

Plena Mixer Amplifier



Security Systems

en | Installation and User Instructions
PLE-1MA030-EU
PLE-1MA060-EU
PLE-1MA120-EU

BOSCH

Important safeguards

Before installing or operating this product, always read the Safety Instructions, which are available as a separate document (9922 141 7014x). These instructions are supplied together with all equipment that can be connected to the mains.

Thank you for choosing a Bosch Security Systems product!

Table of contents

Important safeguards	2
Table of contents	3
1. Introduction	5
1.1 Purpose	5
1.2 Digital document	5
1.3 Intended audience	5
1.4 Related documentation	5
1.5 Alerts	5
1.6 Icons	5
1.6.1 Note icons	5
1.6.2 Caution, Warning, and Danger icons	5
1.7 Conversion tables	6
2. Description	7
2.1 The Plena product range	7
2.2 Contents of box	7
2.3 The Plena Mixer Amplifier	7
2.4 Controls, connectors and indicators	9
2.4.1 Front panel	9
2.4.2 Plena PLE-WP2Z3S wall panel	9
2.4.3 Rear panel	10
3. Installation	13
3.1 Unpack unit	13
3.2 Install unit in rack (optional)	13
3.3 Check settings/connections	13
3.4 Connect unit to mains	13
4. Connections and settings	15
4.1 Connecting inputs	15
4.1.1 Priority microphone (input 1)	15
4.1.2 Secondary microphone (input 2)	16
4.1.3 Additional microphones (inputs 3 and 4)	16
4.1.4 Emergency inputs	17
4.1.5 Music source inputs	19
4.2 Connecting outputs	20
4.2.1 Main output	20
4.2.2 Call only	20
4.2.3 Master output	20
4.2.4 Connecting speakers	21
4.3 Unit settings	22
4.3.1 Rear panel settings	22
4.3.2 Pin settings and labelling	24
5. Operation	25
5.1 Switch on and off	25
5.1.1 Switch on	25
5.1.2 Switch off	25
5.2 Microphone/line controls	26
5.3 Music controls	26

5.3.1	Source selection	26
5.3.2	Volume control	26
5.4	Tone control	26
5.5	Output controls	26
5.5.1	Master volume control	26
6.	Technical data	27
6.1	Electrical	27
6.1.1	Mains power supply	27
6.1.2	Power consumption	27
6.1.3	Performance	27
6.1.4	RJ-45 input 1 x	27
6.1.5	Mic/line input 4 x	27
6.1.6	Music inputs 3x	28
6.1.7	Emergency / telephone 1 x	28
6.1.8	Master/music output 1 x	28
6.1.9	Loudspeaker outputs 100 V	28
6.1.10	Loudspeaker output 4 ohm*	28
6.2	Mechanical	28
6.3	Environmental	28

1 Introduction

1.1 Purpose

The purpose of these Installation and User Instructions is to provide information required for installing, configuring and operating a Plena Mixer Amplifier.

1.2 Digital document

These Installation and User Instructions are also available as a digital document in the Adobe Portable Document Format (PDF).

1.3 Intended audience

These Installation and User Instructions are intended for installers and users of a Plena system.

1.4 Related documentation

Safety Instructions (9922 141 1036x).

1.5 Alerts

Four types of alerts are used in this manual. The alert type is closely related to the effect that may be caused if it is not observed. These alerts - from least severe effect to most severe effect - are:

- **Note**
Alert containing additional information. Usually, not observing a note alert does not result in damage to the equipment or personal injuries.
- **Caution**
The equipment can be damaged if the alert is not observed.
- **Warning**
Persons can be (severely) injured, or the equipment can be seriously damaged, if the alert is not observed.
- **Danger**
Not observing the alert can result in death.

1.6 Icons

1.6.1 Note icons

The icons used in combination with Notes provide extra information about the Note. See the following examples:

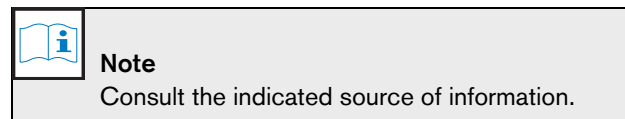
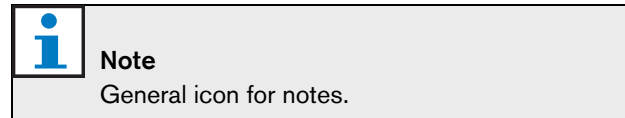

1.6.2 Caution, Warning, and Danger icons

The icons used in combination with Caution, Warnings, and Dangers indicate the type of hazard present. See the following examples:

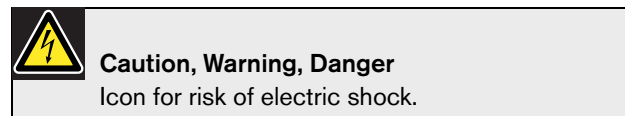

1.7 Conversion tables

In this manual, SI units are used to express lengths, masses, temperatures etc. These can be converted to non-metric units using the following information.

table 1.1: Conversion of units of length

1 in =	25.4 mm	1 mm =	0.03937 in
1 in =	2.54 cm	1 cm =	0.3937 in
1 ft =	0.3048 m	1 m =	3.281 ft
1 mi =	1.609 km	1 km =	0.622 mi

table 1.2: Conversion of units of mass

1 lb =	0.4536 kg	1 kg =	2,2046 lb
--------	-----------	--------	-----------

table 1.3: Conversion of units of pressure

1 psi =	68.95 hPa	1 hPa =	0.0145 psi
---------	-----------	---------	------------



Note

1 hPa = 1 mbar.

$$^{\circ}F = \frac{9}{5}(^{\circ}C + 32)$$

$$^{\circ}C = \frac{5}{9}(^{\circ}F - 32)$$

2 Description

2.1 The Plena product range

The Plena Mixer Amplifier is part of the Plena product range. Plena provides public address solutions for places where people gather to work, worship, trade, or relax. It is a family of system elements that are combined to create public address systems tailored for virtually any application

The Plena product range includes:

- mixers
- preamplifiers
- power amplifiers
- a music source unit
- a digital message manager
- a feedback suppressor
- call stations
- an All-in-One system
- a voice alarm system
- a timer
- a charger
- a loop amplifier

The various elements are designed to complement each other thanks to matched acoustical, electrical and mechanical specifications.

2.2 Contents of box

The packaging box contains the following contents:

- PLE-1MA030-EU, PLE-1MA060-EU, or PLE-1MA120
- Labels and colored pins for indicating favorite settings
- Power cord
- Plena Bonus CD
- Mounting brackets (LBC 1901/00)

2.3 The Plena Mixer Amplifier

The Plena Mixer Amplifier is a high performance, professional public address unit for mixing up to four separate microphone/line signals, and any one of three separate music signals. For a schematic overview of the Plena Mixer Amplifier, see figure 2.1 on the next page.

The volume of each microphone/line signal can be individually adjusted to obtain the required mix; the mixed output is controlled via the master volume control and separate high/low tone controls.

The unit is easy to use, and provides a crisp call or clear music. The amplifier also has enhanced features such as ducking level control, priority, labelling, and setting indicators.

All Microphone/line inputs can be switched between microphone level and line level sensitivity. The inputs are balanced but can also be used unbalanced. Phantom power can be selected via a DIP switch to provide power to condenser microphones. Input channels 1 and 2 can take priority over all other microphone and music inputs:

- Input 1 can be activated by contact closure on a PTT (push to talk). A chime can be configured to precede an announcement.
- Input 2 can be switched automatically if a signal is available at the input, for example, if someone speaks into the microphone (VOX activation).

A telephone/100 V emergency input with VOX activation is also provided for easy integration with another PA system or a telephone paging system. It has its own volume control and overrides all other inputs, including the call station and inputs 1 and 2.

The unit also has a line output to add amplifiers for larger systems that require more output power. This output can be switched to music only, for example, so that music on hold can be provided for the telephone system.

Users can create custom labels for inputs and music sources. These labels can be attached to the special holders at the front of the mixer amplifier. Colored pins can also be inserted at various positions around the volume and tone dial controls to indicate favorite settings for a particular application.

An LED meter monitors the master output before the zone selection. This signal is also present on the headphone connector below the output meter. For total reliability and ease of use, a limiter is integrated into the output stage to restrict output if the user applies too much signal.

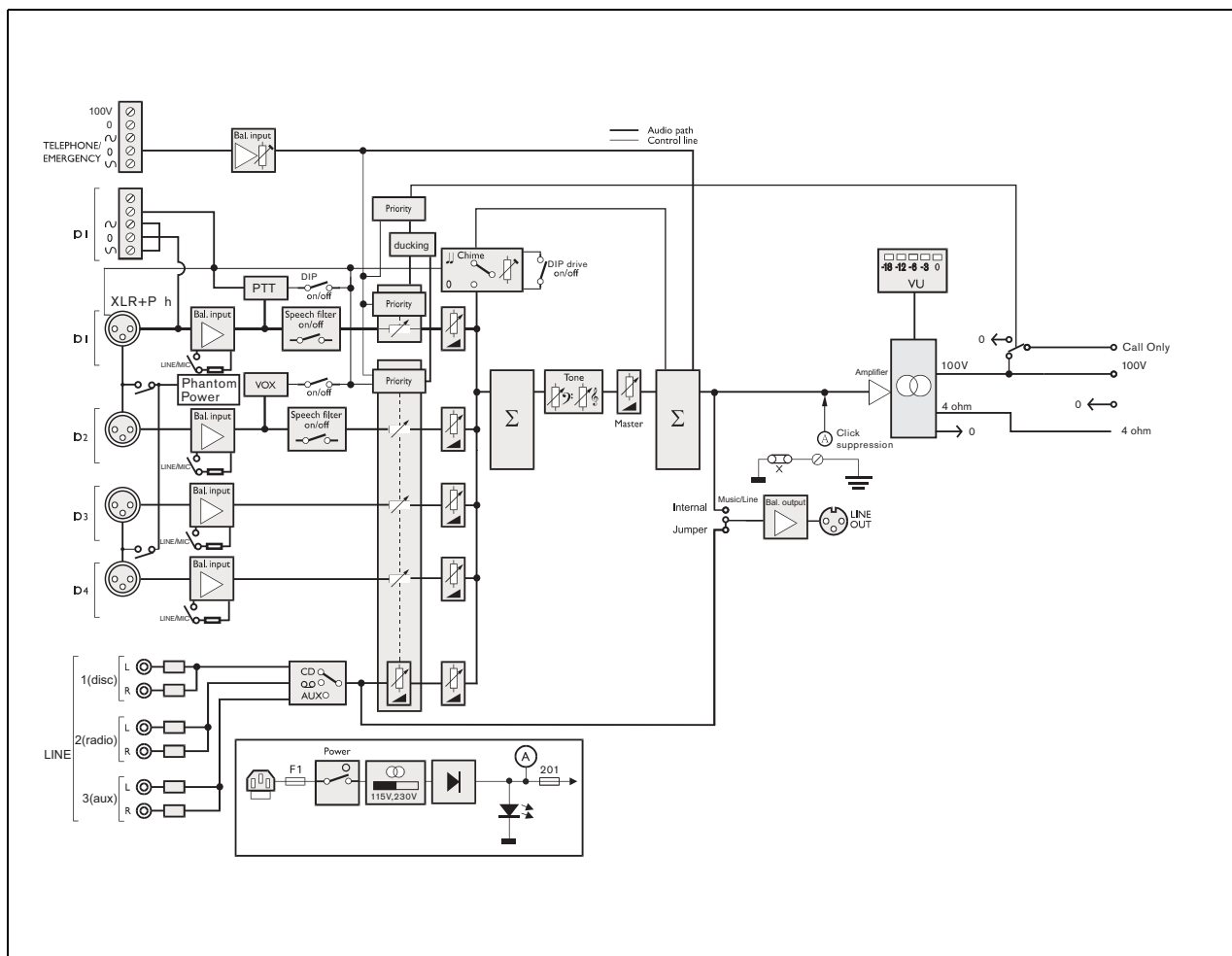

figure 2.1: Schematic overview of the Plena Mixer Amplifier

2.4 Controls, connectors and indicators

2.4.1 Front panel

See figure 2.2 for an overview of the controls and indicators.

- 1 Power button.
- 2 Label holder for user-defined description of microphone/line inputs - custom labels can be created by user.
- 3 Label holder for user-defined description of music sources - custom labels can be created by user.
- 4 Master high tone control.
- 5 Master volume control - controls all inputs except emergency and call station.
- 6 Output level meter (-18 db, 0 db)
- 7 Input level control:
 - microphone/line 1
 - microphone/line 2
 - microphone/line 3
 - microphone/line 4
- 8 Music source selector (for music inputs 1, 2, and 3).
- 9 Music source volume control.
- 10 Master low tone control.
- 11 Air inlet holes.



Note

Do not obstruct the airflow into the unit.



Note

Users can create custom labels for the microphone/line inputs and description of the music sources. These labels can be attached to the mixer amplifier at position numbers 2 and 3 (see figure 2.2). Colored pins can also be inserted at various positions around the dial controls to indicate the favorite settings for a particular application. For more information on inserting and removing pins, see section 4.3.2.

2.4.2 Plena PLE-WP2Z3S wall panel

The optional Plena PLE-WP2Z3S wall panel can be used to remotely control the unit from a maximum of four remote locations. The appearance of the wall panel is matched to the Bosch loudspeaker volume controls.

The music source can be easily changed. The status of each music source is indicated by an LED.

A standard CAT 5 cable is used to connect the wall panel to the mixer-amplifier. The maximum distance is 200 m. Please refer to the relevant datasheet for more information.

- 12 Headphone socket.

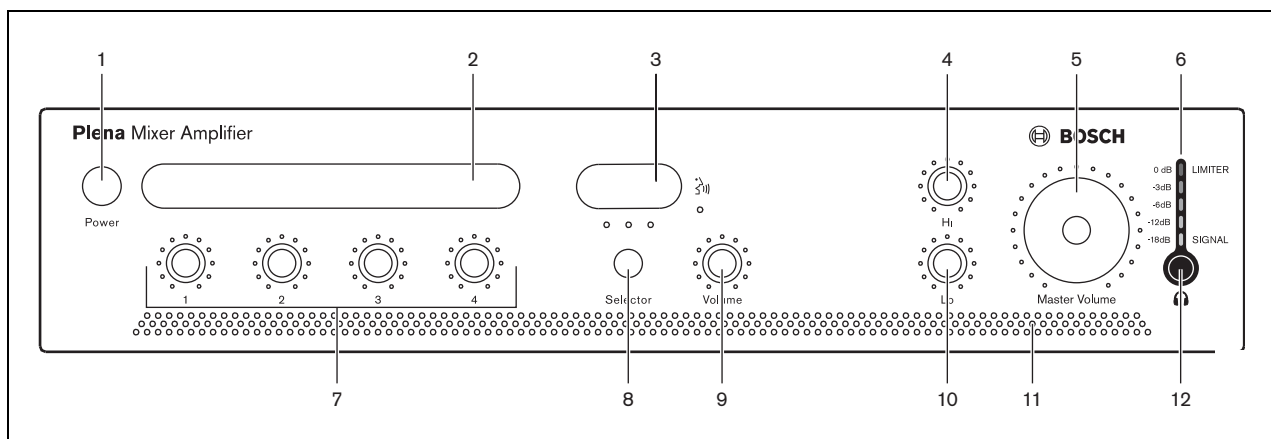

figure 2.2: Front panel

2.4.3 Rear panel

See figure 2.3 for an overview of the connectors and switches:

- 1 Tel. emergency/100V input, Euro style pluggable screw terminal connector - VOX function. This input has highest priority.
- 2 Telephone emergency/100V input volume control - control range -25 dB to 0dB (see number 1).
- 3 Remote control wall-panel-input, RJ-45 connector. Wall panel incorporates: BGM source selection, and zone on/off control.
- 4 Ducking level control for microphone/line inputs 1 and 2.
- 5 Music input (number 1 disc), 2x RCA/cinch connectors. Stereo, summed mono.
- 6 Music input (number 2 radio), 2x RCA/cinch connectors. Stereo, summed mono.
- 7 Music input (number 3 auxiliary), 2x RCA/cinch connectors. Stereo, summed mono.
- 8 Music master output, XLR connector - switch setting for line out, or music only. This output can carry out either music only, or the master output. For more information, see chapter 4.2.3.
- 9 Cooling fan (PLE-1MA120 only).
- 10 Microphone/line 1 input with trigger, Euro style pluggable screw terminal connector - DIP switch settings for: chime, PTT (push to talk), mic/line, speech filter, and phantom power (see number 12). Input is wired in parallel with microphone/line 1, XLR connector (see number 11).
- 11 Microphone/line 1 input, XLR connector - DIP switch settings for: chime, PTT (push to talk), mic/line, speech filter, and phantom power (see number 12). Input is wired in parallel with microphone/line 1, Euro style pluggable screw terminal connector (see number 10).
- 12 DIP switch for microphone/line 1 and microphone/line 2 (see numbers 10 and 11, and 13 respectively).
- 13 Microphone/line 2 input, XLR connector - DIP switch settings for speech filter, mic/line, VOX, and phantom power (see number 12).
- 14 Microphone/line 3 input, XLR connector - DIP switch settings for mic/line, and phantom power (see number 15).
- 15 DIP switch for microphone/line 3 and microphone/line 4 (see numbers 14 and 16 respectively).
- 16 Microphone/line 4 input, XLR connector - DIP switch settings for mic/line, and phantom power (see number 15).
- 17 Outputs:
 - Call only, screw terminal connector 100 V.
 - Screw terminal connector 100 V, and 4 ohm.
- 18 Mains fuse.
- 19 Earth connection screw.
- 20 Mains connector (3-pole).



Note

The unit must be earthed.



Note

Always allow adequate space at the rear of the unit for ventilation.

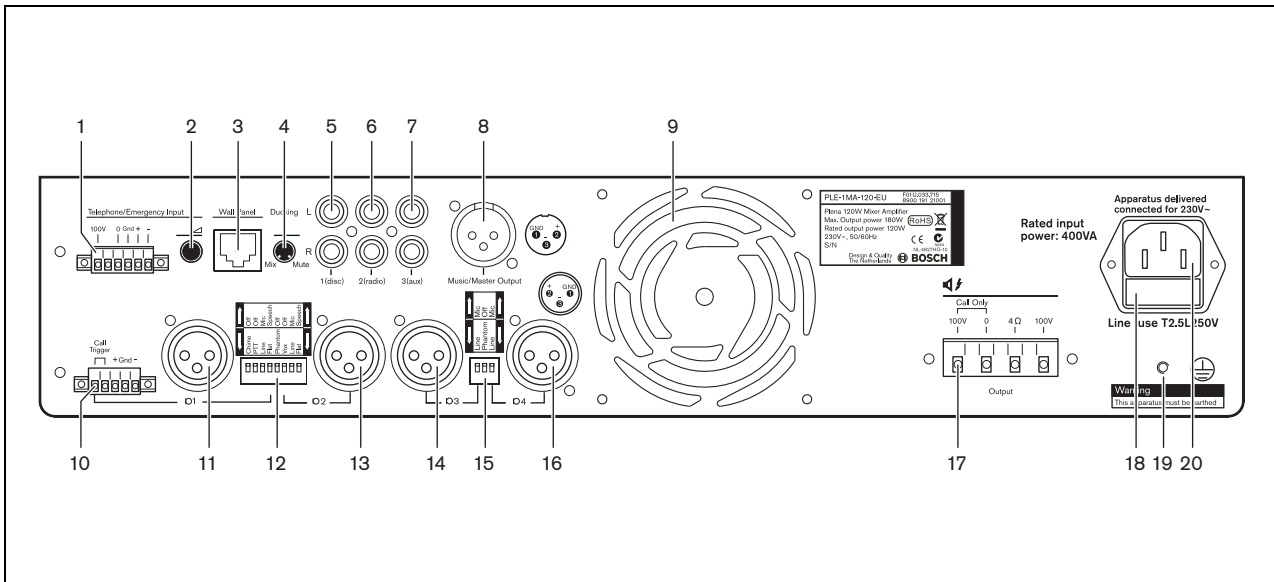

figure 2.3: Rear panel

Intentionally left blank

3 Installation

3.1 Unpack unit

- 1 Remove the unit from the box, and discard the packaging material according to local regulations.
- 2 Use your fingernails to carefully peel off the protective plastic film from the label holders. Do not use sharp or pointed objects.

3.2 Install unit in rack (optional)

The Plena Mixer Amplifier is intended for tabletop use, but you can also mount the unit in a 19" rack (see figure 3.1).

If you mount the unit in a rack, you must:

- ensure that it does not exceed the overheating temperature (45 °C ambient).
- use the included Bosch mounting brackets (LBC 1901/00).
- remove the 4 feet from the bottom of the unit.

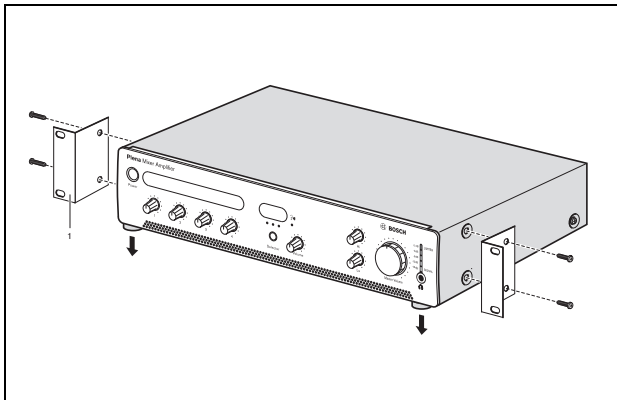

figure 3.1: Installing the unit in a rack

3.3 Check settings/connections

- 1 Connect any additional equipment (see section 4.1 and 4.2).
- 2 Check the settings (see section 4.3).

3.4 Connect unit to mains



Caution

Potential equipment damage. Before connecting power, always check the voltage indicator plate at the rear of the unit.

- 1 Make sure the power switch on the front of the unit is set to Off.
- 2 Connect the power cord to the mains connector and plug it into the mains outlet.

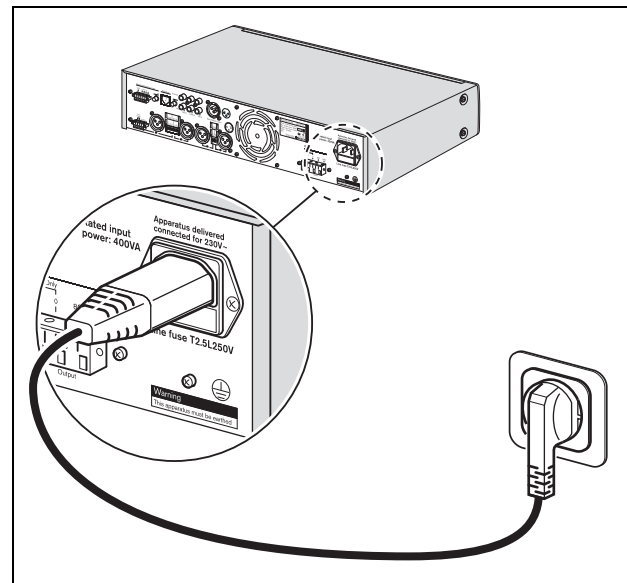

figure 3.2: Power connection and voltage selector

Intentionally left blank

4 Connections and settings

4.1 Connecting inputs

4.1.1 Priority microphone (input 1)

The priority microphone (or a generic call station) that can be used with push to talk (PTT) should be connected to “microphone/line 1 input”. The PTT mode can be activated by setting the DIP switch (12) at the rear of the unit. Microphone/line 1 input has priority over all other microphone/line inputs.

If, however, the “Tel. emergency/100V input” receives a signal, all inputs including microphone/line 1 input will be overruled.

The microphone/line 1 input has two connectors wired in parallel:

- an XLR connector (for a 3 pole microphone), and
- a Euro style pluggable screw terminal connector.

The Euro style pluggable screw terminal connector has a trigger input, which can be used in combination with the Euro and XLR connector.

The priority microphone can be connected to the microphone/line 1 input as follows:

- XLR connector only. See figure 4.1.
- XLR connector with trigger. See figure 4.2.
- Euro connector with trigger. See figure 4.3.
- Euro connector only (without trigger).



Note

If a microphone is connected to both the XLR connector and the Euro connector for the microphone/line 1 input, the input signals will be added together.

Set the DIP switch settings next to the XLR connector for microphone/line 1, as required. See section 4.3.



Note

When connecting an unbalanced line level (200 mV) signal to the microphone/line input, connect it as follows: Signal to pin 2, pin 1 and pin 3 to ground.

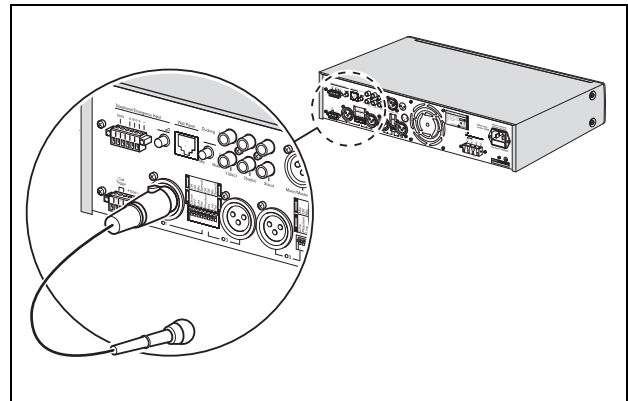

figure 4.1: XLR connector only

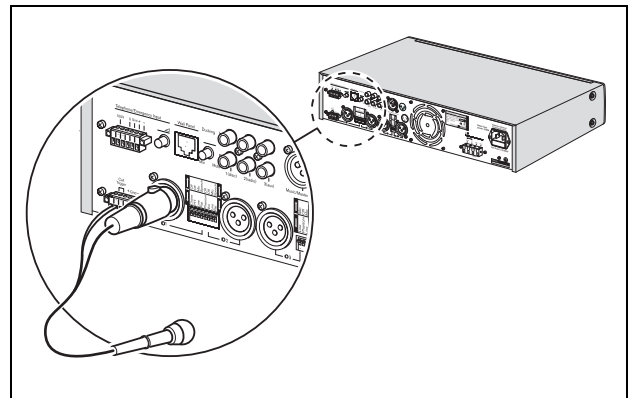

figure 4.2: XLR connector with trigger

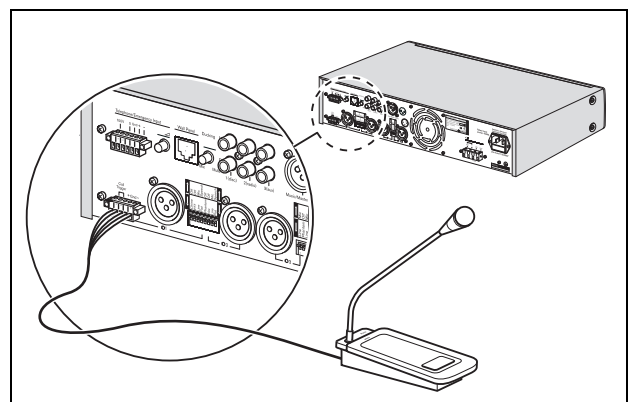

figure 4.3: Euro connector with trigger

4.1.2 Secondary microphone (input 2)

Connect a secondary microphone to “microphone/line input 2”. See figure 4.4.

Microphone/line input 2 has a DIP switch (12) at the rear of the unit for setting the VOX mode. If the DIP switch is set to VOX, the microphone/line input will automatically be switched when a signal is sensed at the microphone/line 2 input. For example, when someone speaks into the microphone, other sound will either be muted or ducked, depending on the setting of the ducking level control at the rear of the unit. See section 4.3.

The Tel. emergency/100V input and Microphone/line input 1 all have priority over the Microphone/line input 2. Therefore, any signal received on any one of these inputs will always be heard regardless of the ducking level control setting for Microphone/line input 2.

Set the DIP switch settings next to the XLR connector as required. See section 4.3.

4.1.3 Additional microphones (inputs 3 and 4)

Connect additional microphones to microphone/line inputs 3 and 5 as required. See figure 4.4. These microphones will mix with the background music.

Set the DIP switch settings next to the XLR connector for microphone/lines 3 and 4, as required. See section 4.3.

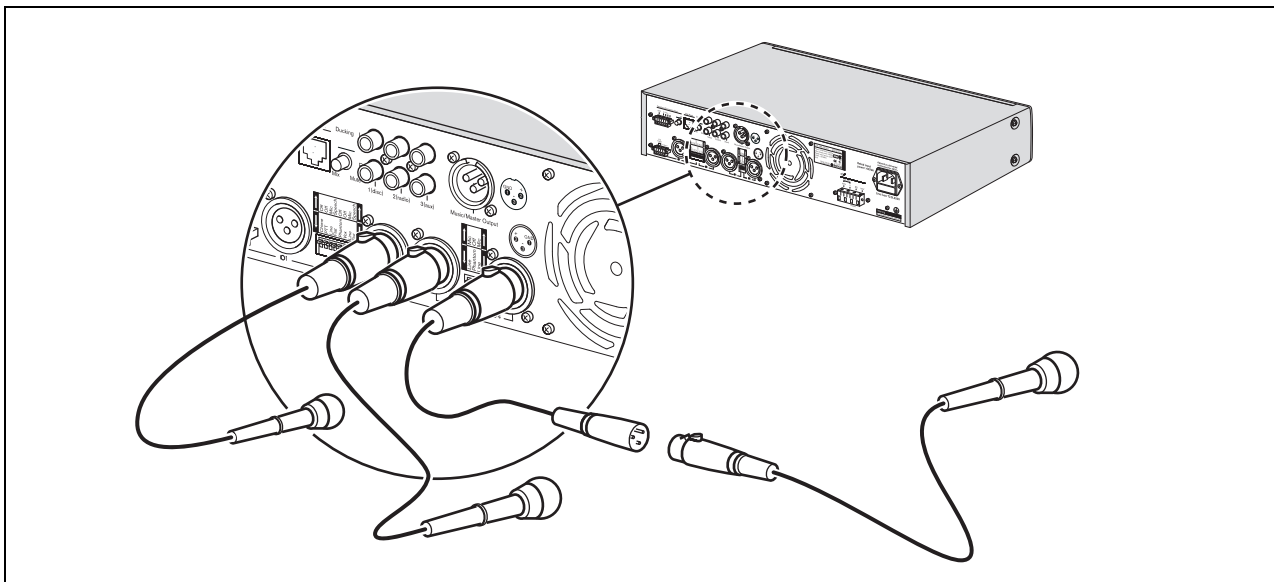

figure 4.4: Connecting microphone inputs

4.1.4 Emergency inputs

The Tel. emergency/100V input, with VOX functionality, is used for receiving emergency announcements or signals (such as a fire alarm). This input has absolute priority, and will overrule all inputs when an emergency announcement or signal is received.

Either a telephone line or a 100 V input signal can be connected to the Euro style pluggable screw terminal connector (1) at the rear of the unit. See section 4.1.4.1 and section 4.1.4.2.



Caution

Never connect telephone lines and a 100 V signal to the Euro style connector at the same time.

To adjust the volume of the emergency announcement or signal, turn the rotary dial (2) at the rear of the unit. For safety reasons, the volume of the emergency announcement or signal cannot be set to zero.

The master volume control setting (5) does not influence the volume setting of the emergency announcement or signal.



Note

Tel. emergency input does not mute the incoming signal so that an incoming pilot tone will be fed to the zone outputs. With this feature it is possible to use the mixer amplifier in a Bosch Voice Alarm System when using end of line boards (PLN-1EOL).

The signal that is delivered to the unit should be quiet when a call is not made. The pilot tone and frequencies below 300 Hz are filtered from the trigger signal so that the input will not trigger from a pilot tone or low frequency rumble.

4.1.4.1 Connecting 100 Volt input signal

Connect the 100 Volt input signal as shown in figure 4.5.

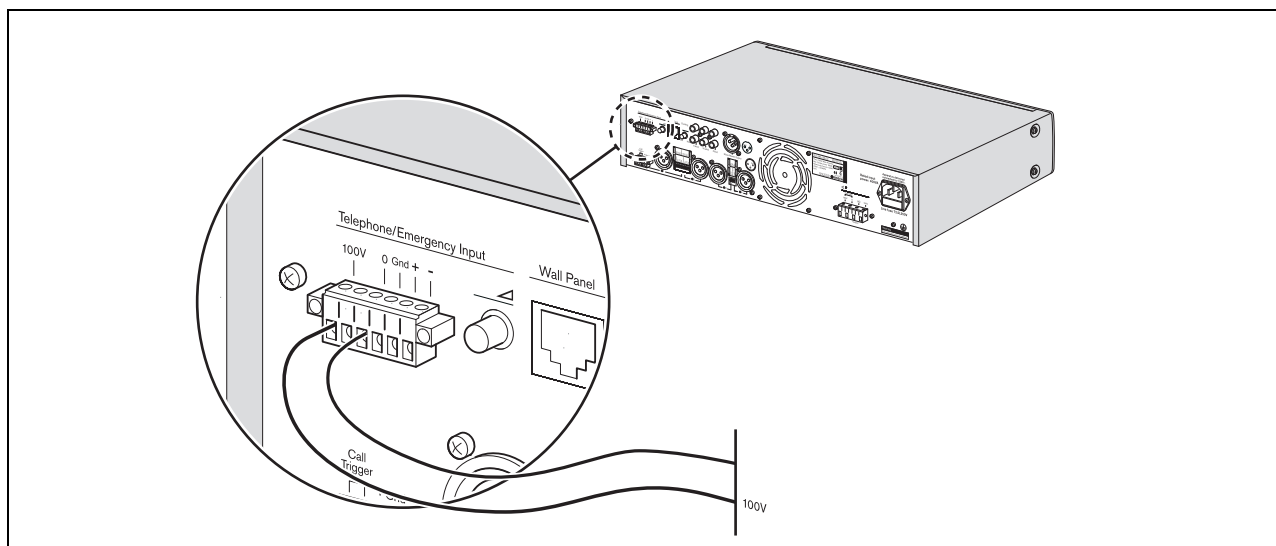

figure 4.5: Connecting 100 Volt input signal

4.1.4.2 Connecting telephone lines

Connect the telephone lines as shown in figure 4.6.



Caution

A connection to a telephone network must always be made via a telephone coupler that provides adequate isolation between the telephone network (PBX) and the Plena system. The telephone coupler must also meet all relevant requirements for this type of communication equipment as imposed by law and/or responsible telecommunication organizations in the country of use. Never try to make a direct connection between the telephone network and the mixer amplifier.

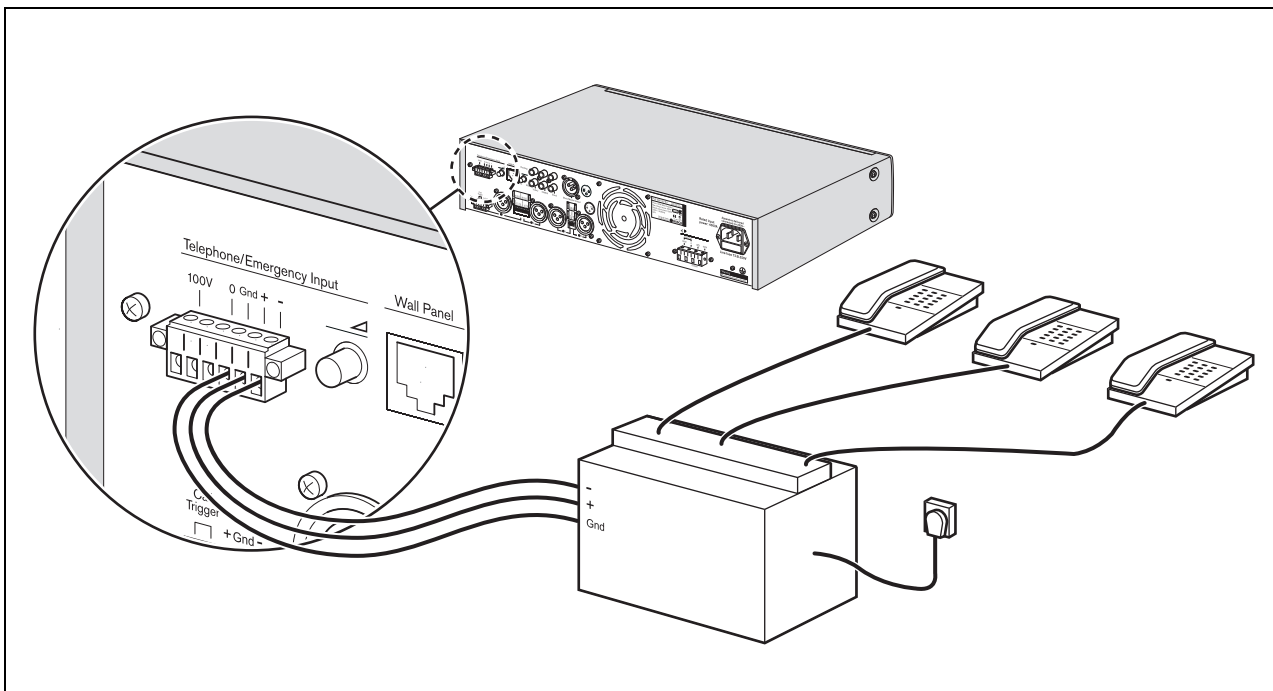

figure 4.6: Connecting emergency telephone lines

4.1.5 Music source inputs

When using a CD player, tuner or other auxiliary device for background music, connect the line-out connectors of the music source to the appropriate line-in connectors of the mixer amplifier.

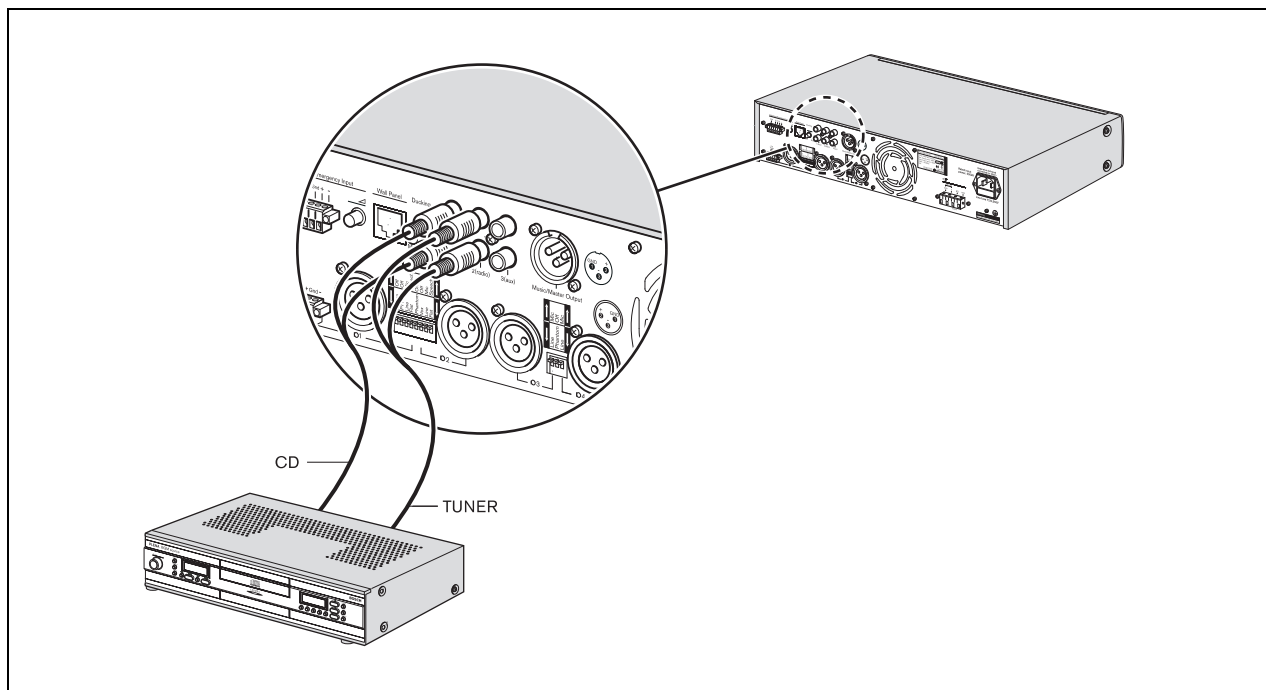

figure 4.7: Connecting music source inputs

4.2 Connecting outputs

4.2.1 Main output

Connect speakers to the 100 V or 4 ohm terminal on the Euro style pluggable screw terminal connector (17) at the rear of the unit.

Also see section 4.2.4 “Connecting speakers”.

4.2.2 Call only

Connect speakers to the 100 V terminal on the Euro style pluggable screw terminal connector (17) at the rear of the unit.

Also see section 4.2.4 “Connecting speakers”.

4.2.3 Master output

This output carries the master output of the mixer at line level (1 V balanced).

To hear music only set the internal jumper.

Use the music output connector (8) to provide a dedicated music out source for another device. For example, the music master output can be connected to a telephone coupler, so that callers can listen to music when they are put on hold (see figure 4.8).

To select the dedicated music out source, set the internal jumper. Only the music inputs (5, 6, and 7) will be audible. All other inputs, including the Tel. emergency/100V input will not be sent to this output.

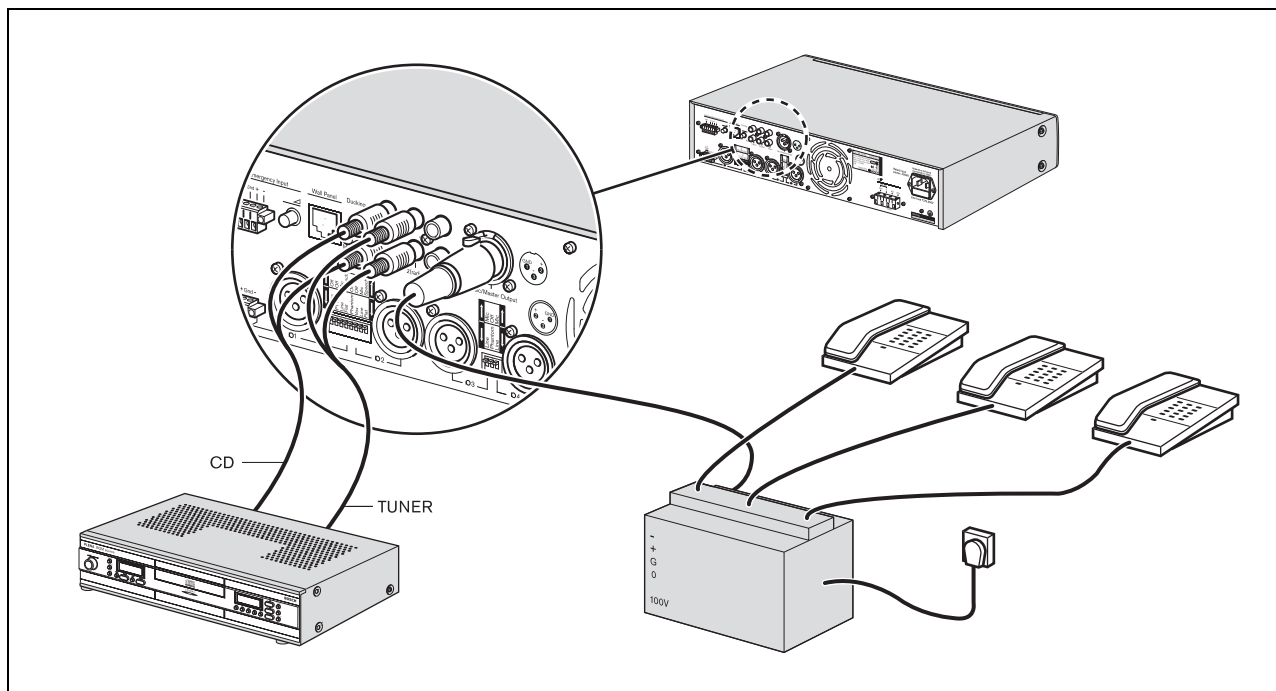

figure 4.8: Connecting music source inputs

4.2.4 Connecting speakers

4.2.4.1 Constant voltage loudspeakers

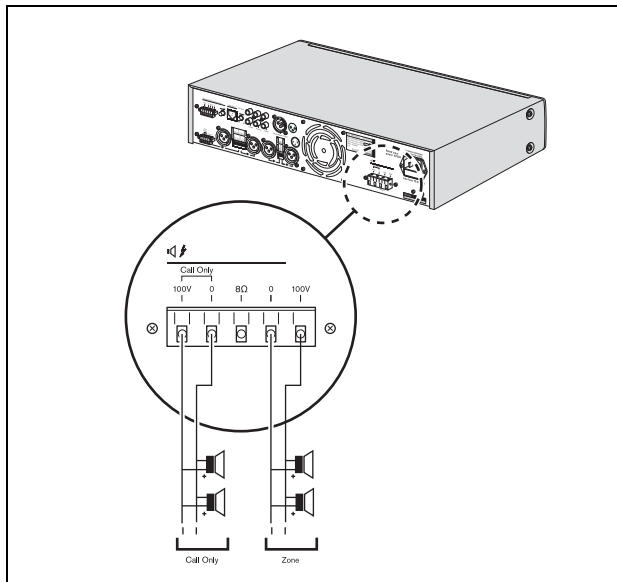

figure 4.9: Connecting speakers

The mixer amplifier can drive 100 V constant voltage loudspeakers.

Connect the loudspeakers in parallel and check the loudspeaker polarity for in-phase connection. The summed loudspeaker power should not exceed the rated amplifier output power.

You can use the Call Only output for 3-wire remote volume control override. You can also use this output as an extra zone where announcements can be heard, but not music.

4.2.4.2 Low impedance loudspeakers

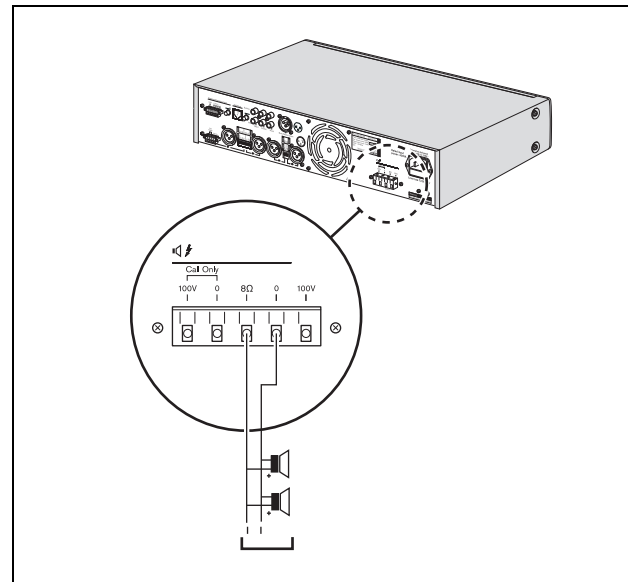

figure 4.10: Connecting speakers

Connect low impedance loudspeakers to the 4 ohm/0 terminals. This output can deliver the rated output power into an 4 ohm load. Connect multiple loudspeakers in a series/parallel-arrangement to make the combined impedance 4 ohm or higher. Check the loudspeaker polarity for in-phase connection.

4.3 Unit settings

4.3.1 Rear panel settings

The unit can be quickly set-up for operation by setting the following controls at the rear of the unit:

- DIP switches
- Rotary dials.

See the following tables for an overview of the settings and typical examples of their use.

table 4.1: DIP switch settings

DIP switch	On	Off	Typical example (On)
Chime (mic/line 1)	Chime will be sounded at the beginning of an announcement.	Chime will not be sounded at the beginning of an announcement.	Announcement of train departure time.
PTT "Push to talk" (mic/line 1 only)	This input is muted when the push to talk contact is open. When the push to talk contact is closed: <ul style="list-style-type: none"> • this input is available for speech. • a chime will sound, if selected. • the music and other mic/line inputs will be reduced in volume to the level set by the ducking level control knob. 	Push to talk off. The signal will be mixed with the other mic/line signals. Microphone 1 will mix with the background music or the other microphones in the selected zones.	Users can have private conversations during live broadcasts (for example, with an all call call-station, such as the PLE-1CS).
Line	Input signal from line.	Input signal from microphone.	Depends on set-up.
Speech filter	Enhances clarity of speech, by cutting-off the lower frequencies of the signal.	Speech filter inactive.	Use for announcements
Phantom power	Provides power to condenser microphones.	Phantom power unavailable.	Enable phantom power if you use electret or condenser microphones.
VOX (mic/line 2 only)	Temporarily suppresses the background music to an adjustable "ducking level" (see table 4.2) while you speak into the microphone. The VOX mode is normally used with hand-held microphones such as the LBC 2900/15. Background music and announcements will be heard in the selected zones. A chime is not available in this mode.	VOX inactive. Microphone 2 will mix with the background music or the other microphones in the selected zones.	Use to make casual announcements (such as announcing the winner of a competition) while temporarily suppressing the background music to an adjustable ducking level.

table 4.2: Rotary controls

Rotary control	Effect	Typical example
Ducking level control	Sets the required ducking level when VOX and/or push to talk is active (see table 4.1). When the ducking level is set to mute, the music volume will be fully attenuated; when the ducking level is set to mix, both music and speech inputs can be heard - music and speech will be mixed. When ducking the music input is ducked (attenuated), the microphone/line inputs are always muted when a call is made.	Set the ducking level control to mute if you want the announcement to be heard without background music.
Telephone emergency/100V volume control	Attenuates the emergency announcement or signal. Control range from -25 dB to 0 dB. For safety reasons, the volume of the emergency announcement or signal cannot be fully set to zero.	Set the volume of the emergency announcement to a higher level when the system is being used in large open areas.

**Note**

When PTT or VOX are selected, the ducking control controls between 3 dB attenuation (very little ducking) to $-\infty$ dB (muted).

When ducking, the music is also present on the Call only output. If you do not want this, set the ducking control to mute.

4.3.2 Pin settings and labelling

Users can create custom labels for the: microphone/line inputs, description of the music sources, and audio output zones 1 and 2. These labels can be attached to the mixer amplifier at position numbers 2 and 3 (see figure 2.2). Colored pins can also be inserted at various positions around the dial controls to indicate the favorite settings for a particular application.

The pins are engineered in such a way that they cannot be taken out by hand. This is to prevent tampering. The pins are intended to be inserted once, during installation of the unit. The silver pins should be used to indicate the preferred settings of the unit. The red pins can optionally be used to indicate the maximum setting of a knob.

If these settings have to be changed, use a pair of soft-tipped pliers to carefully remove the pins. If you do not have a pair of soft-tipped pliers, you can use ordinary pliers instead, but first place some plastic tape on the tips of the pliers to prevent damaging the front of the unit.

To remove the clear plastic covers in front of the labels:

- 1 Carefully insert a small screwdriver into the cut-out at the bottom of the plastic cover.
- 2 Gently lift the cover, and bend it in the middle. Take care not to force the cover or the front panel.

To reattach the plastic covers with paper labels:

- 1 Insert the paper label into the holder at the front of the unit.
- 2 Pick up the cover, and then bend it slightly in the middle by hand.
- 3 Fit the cover into the slot at the front of the unit, and then gently release the cover, making sure that the paper label stays in place.

5 Operation

5.1 Switch on and off

5.1.1 Switch on



Caution

Potential equipment damage. Before applying power, always check the voltage indicator plate at the rear of the unit.

- 1 Set the power button (1) on the front of the unit to On - pushed in (see figure 5.1).

5.1.2 Switch off

Set the power button (1) on the front of the unit to Off - popped out (see figure 5.1).

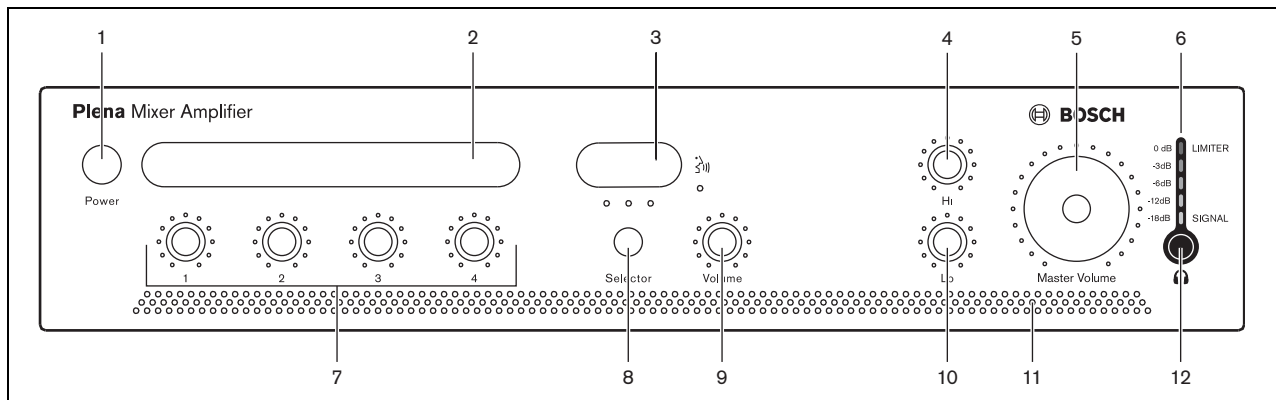

figure 5.1: Front panel

5.2 Microphone/line controls



Note

Users can create custom labels for the microphone/line inputs and description of the music sources. These labels can be attached to the mixer amplifier at position numbers 2 and 3 (see figure 5.1). Colored pins can also be inserted at various positions around the dial controls to indicate the favorite settings for a particular application.

Use the volume controls (7) to individually control the sound level of microphone/line inputs 1 through 4.

5.3 Music controls

5.3.1 Source selection

Use the music source selector (8) to select one of the connected music sources.

5.3.2 Volume control

Use the music source volume control (9) to control the sound level of the selected music source.

5.4 Tone control

The tone controls are not standard bass and treble controls: they can be used as a traditional tone control with high and low control, but also have a powerful contour that addresses problems found in real situations.

The tone control for the low frequencies boosts deep bass first without making the sound boomy, and cuts rumble without losing warmth in the low frequencies.

Use the Hi (high) and Lo (low) tone controls (see figure 5.1, numbers 4 and 10) to change the tone.

5.5 Output controls

5.5.1 Master volume control

Use the master volume control dial (5) to collectively control the sound level of all outputs, except the emergency announcement/signal.

6 Technical data

6.1 Electrical

6.1.1 Mains power supply

Voltage

230 VAC, $\pm 10\%$, 50/60 Hz

Inrush Current PLE-1MA030-EU

4.5 A

Inrush Current PLE-1MA060-EU

5 A

Inrush Current PLE-1MA120-EU

10 A

6.1.2 Power consumption

PLE-1MA030-EU

100 VA

PLE-1MA060-EU

200 VA

PLE-1MA120-EU

400 VA

6.1.3 Performance

Frequency response

50 Hz to 20 kHz (+1/-3 dB @ -10 dB ref. rated output)

Distortion

<1% @ rated output power, 1 kHz

Bass Control

Max -12/+12 dB (frequency is level dependent)

Treble Control

Max -12/+12 dB (frequency is level dependent)

6.1.4 RJ-45 input 1 x

Wall panel input

For PLE-WP3S2Z

6.1.5 Mic/line input 4 x

Input 1 (Push-to-talk contact with ducking functionality)

5-pin Euro style, balanced, phantom

3-pin XLR, balanced, phantom

Input 2-4 (VOX with ducking functionality on input 2)

3-pin XLR, balanced, phantom

Sensitivity

1 mV (mic); 200 mV (line)

Vox sensitivity

-15 dB (attack time 20 ms; release time 4 s)

Impedance

>1 kohm (mic); >5 kohm (line)

S/N (flat at max volume)

63 dB (mic); >70 dB (line)

S/N (flat at min volume/muted)

>75 dB

Dynamic range

100 dB

S/N (flat at max volume)

>63 dB (mic); >70 dB (line)

S/N (flat at min volume/muted)

>75 dB

CMRR

>40 dB (50 Hz to 20 kHz)

Headroom

>25 dB

Speech filter

-3 dB @ 315 Hz, high-pass, 6 dB/oct

Phantom power supply

16 V via 1.2 kohm (mic)

6.1.6 Music inputs 3x

Connector	Cinch, stereo converted to mono
Sensitivity	200 mV
Impedance	22 kohm
S/N (flat at max volume)	>70 dB
S/N (flat at min volume/muted)	>75 dB
Headroom	>25 dB

6.1.7 Emergency / telephone 1 x

Connector	7-pin, Euro style pluggable screw connector
Sensitivity tel	100 mV – 1 V adjustable
Sensitivity 100V	10 V – 100 V adjustable
Impedance	>10 kohm
S/N (flat at max volume)	>65 dB
VOX	threshold 50 mV; attack time 150 ms; release time 2 s

6.1.8 Master/music output 1 x

Connector	3-pin XLR, balanced
Nominal level	1 V
Impedance	<100 ohm

6.1.9 Loudspeaker outputs 100 V

Connector	Screw connector, floating
Max / rated PLE-1MA030-EU	45 W / 30 W
Max / rated PLE-1MA060-EU	90 W / 60 W
Max / rated PLE-1MA120-EU	180 W / 120 W

6.1.10 Loudspeaker output 4 ohm*

Connector	Screw terminal, floating
PLE-1MA030-EU	11 V (30 W)
PLE-1MA060-EU	16 V (60 W)
PLE-1MA120-EU	22 V (120 W)

6.2 Mechanical

Dimensions (H x W x D)	100 x 430 x 270 mm (19" wide, 2U high)
Mounting	Stand-alone, 19" rack
Color	Charcoal
Weight (PLE-1MA030-EU)	Approx. 5 kg
Weight (PLE-1MA060-EU)	Approx. 8.5 kg
Weight (PLE-1MA120-EU)	Approx. 10.5 kg

6.3 Environmental

Operating temperature	-10 to +45 °C
Storage temperature	-40 to +70 °C
Relative humidity	<95%
Acoustic noise level of fan (PLE-1MA120-EU)	<33 dB SPL @ 1 m

© Bosch Security Systems B.V.

Data subject to change without notice

2014-01 | PLE-1MA030-EU, PLE-1MA060-EU, PLE-1MA120-EU en

BOSCH